

Gehäuseoberteil
Innenansicht
Top part of case
inside view

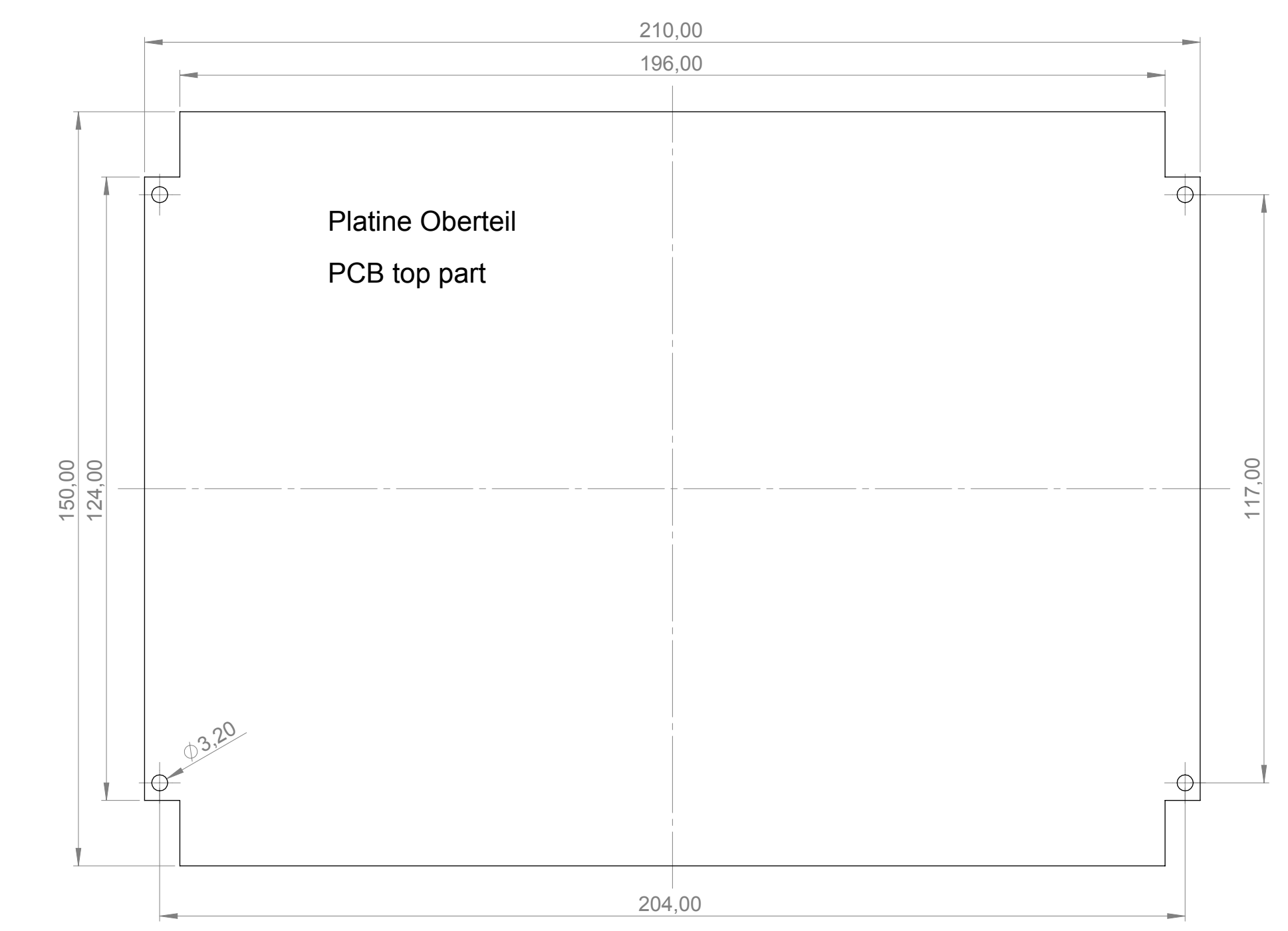

Platine Oberteil
PCB top part

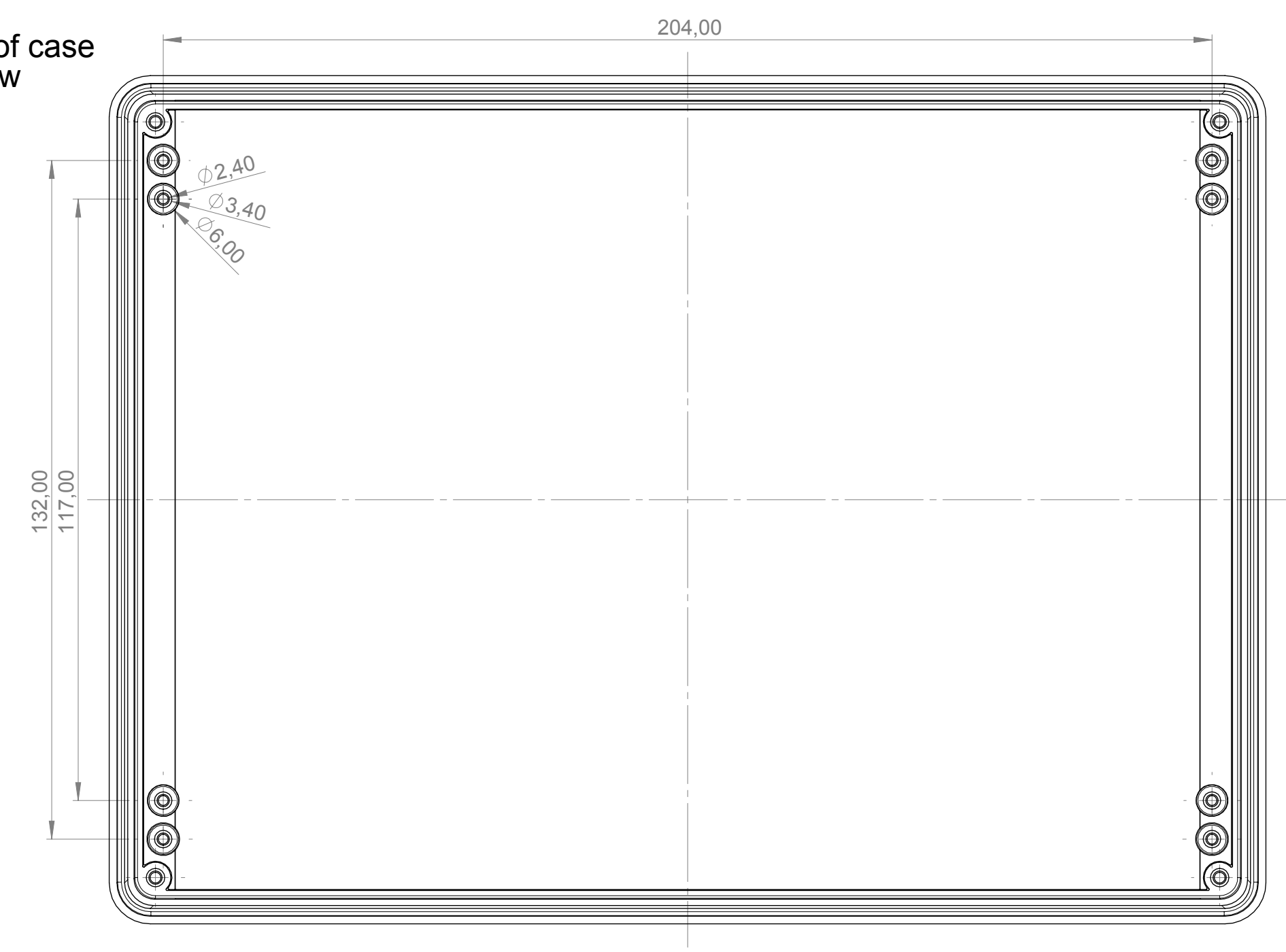
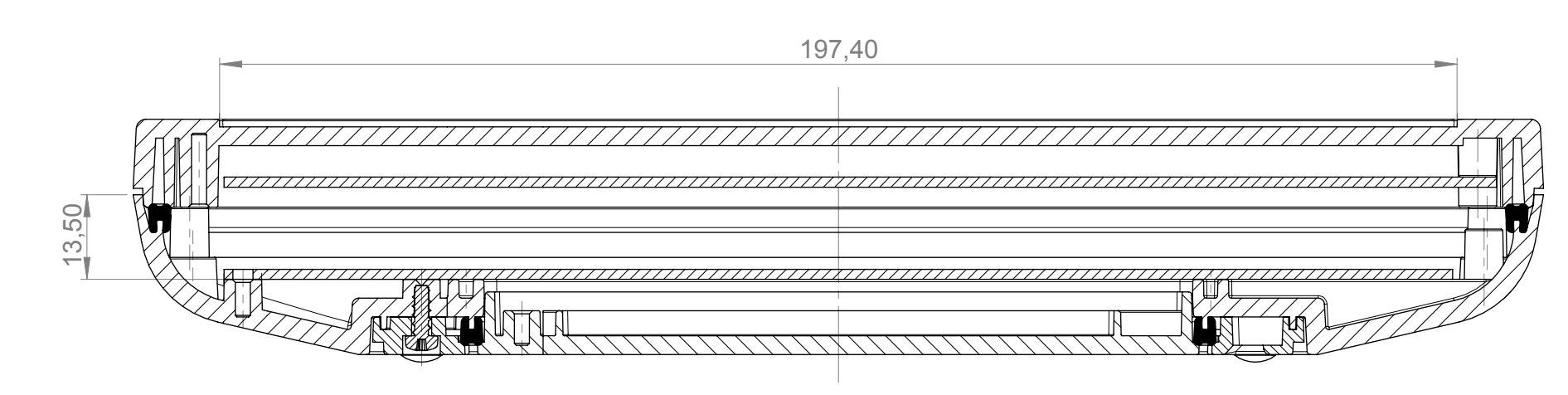
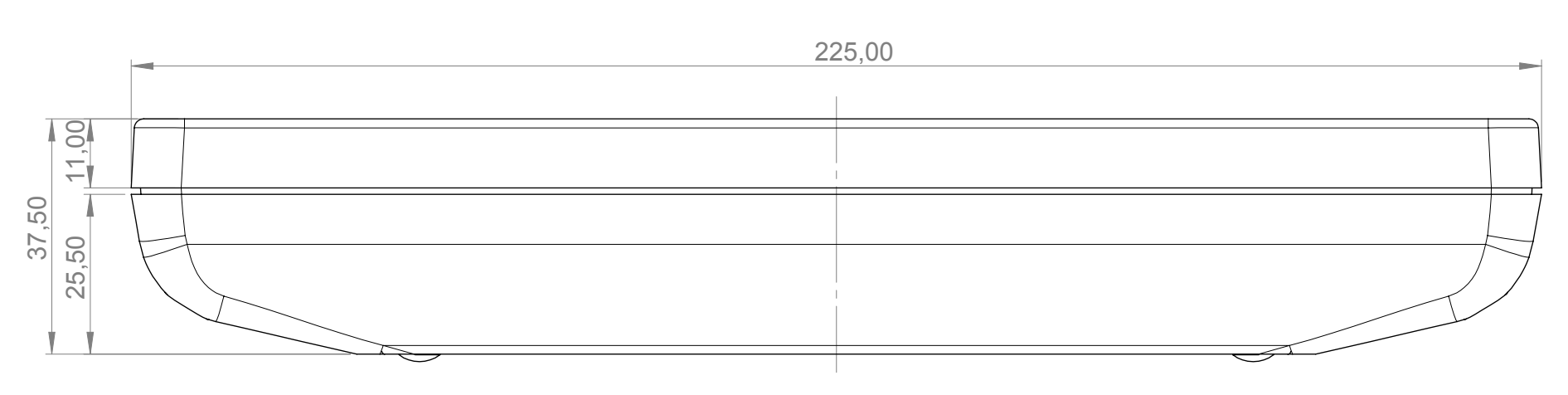

A-A

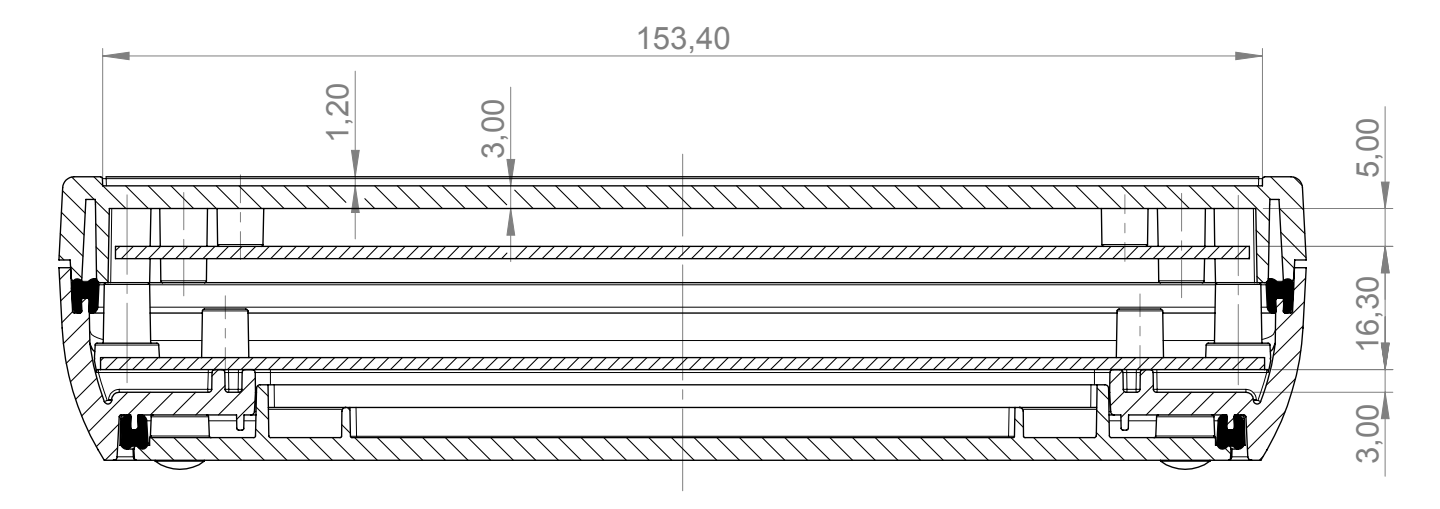

B-B

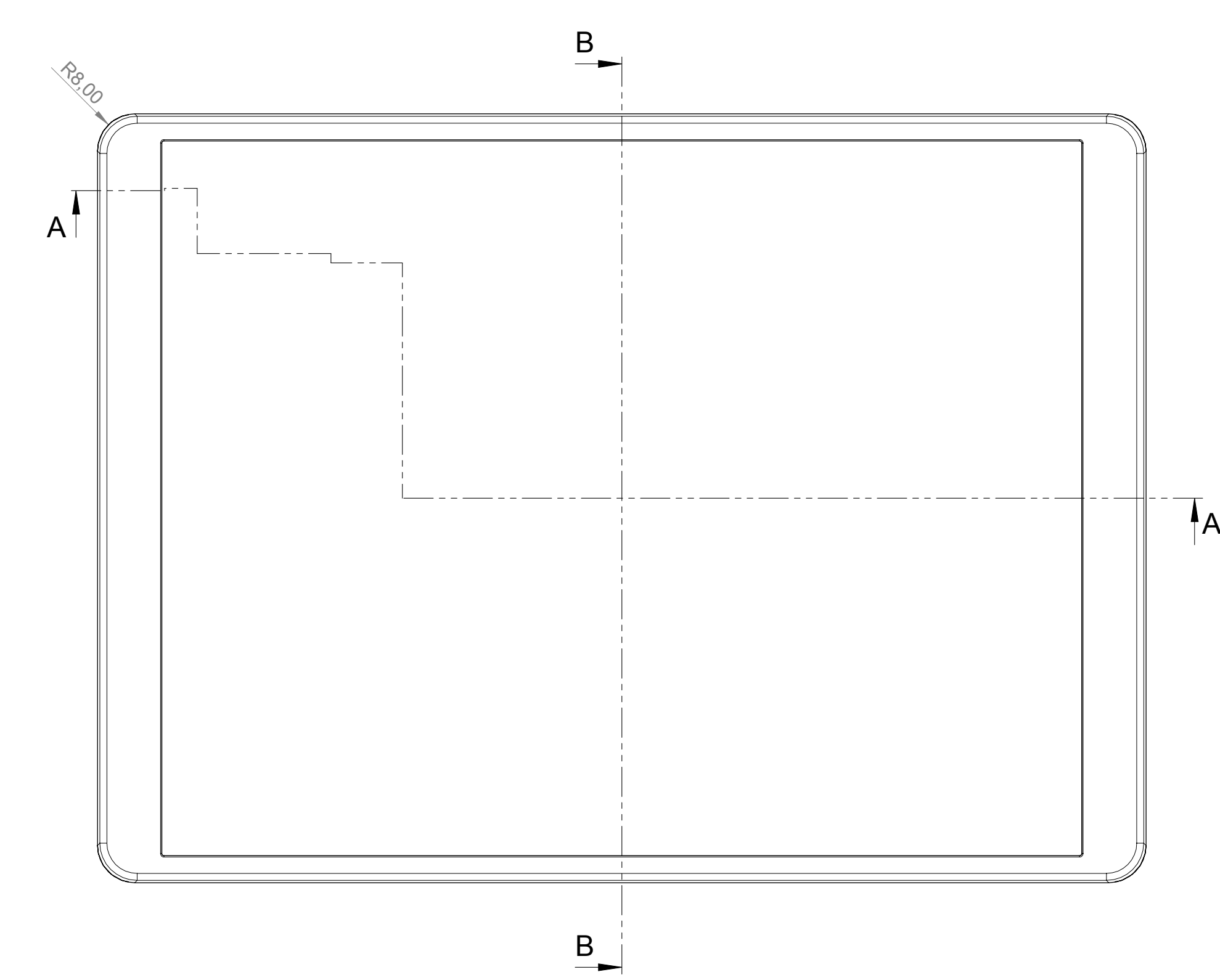
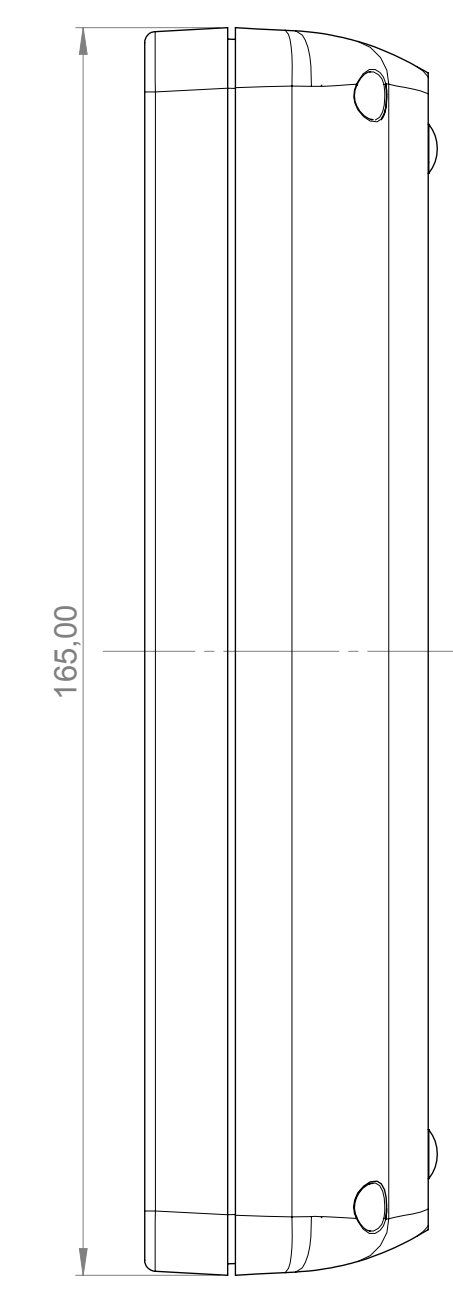

Gehäuseunterteil
Innenansicht
Bottom part of case
inside view

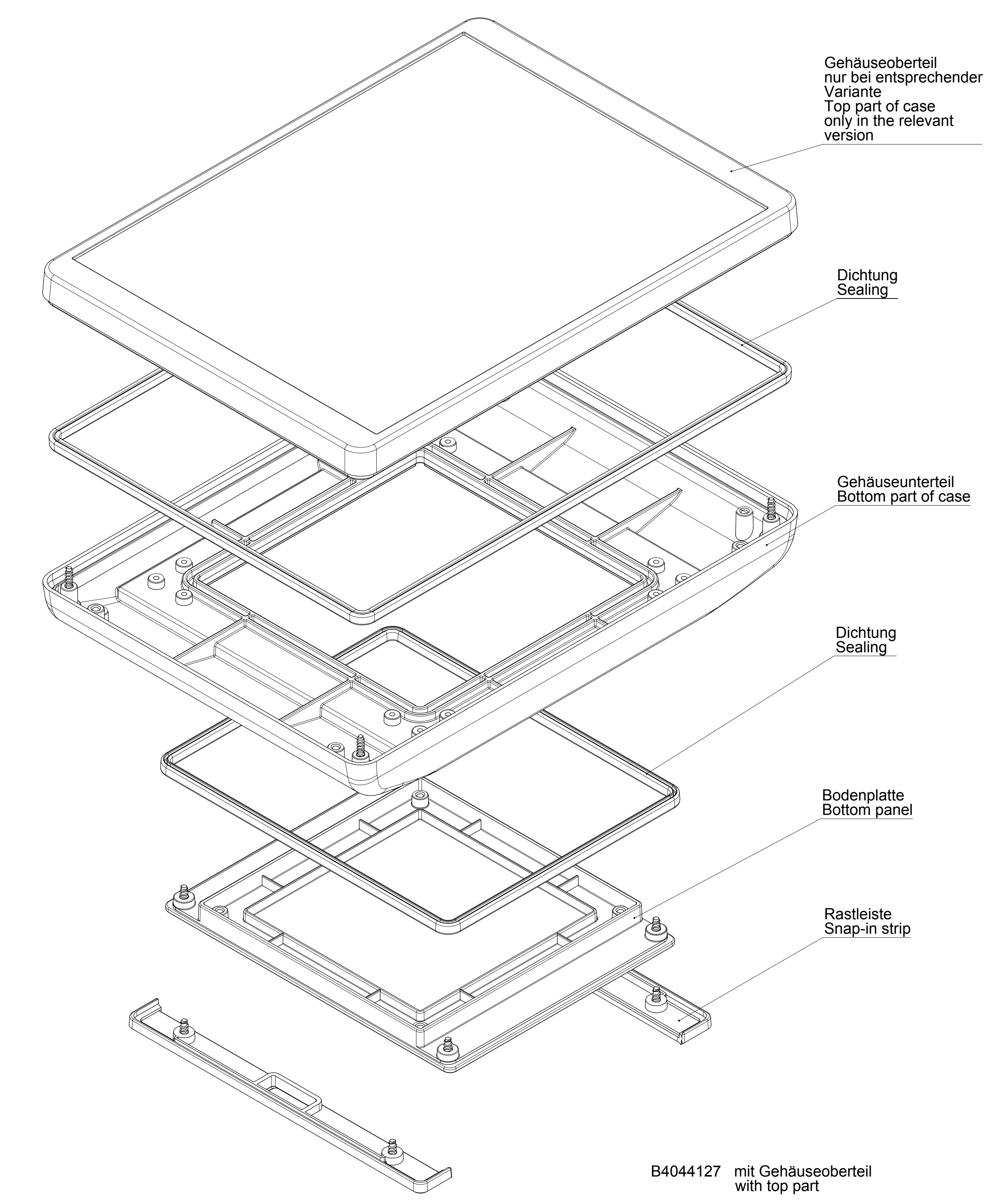
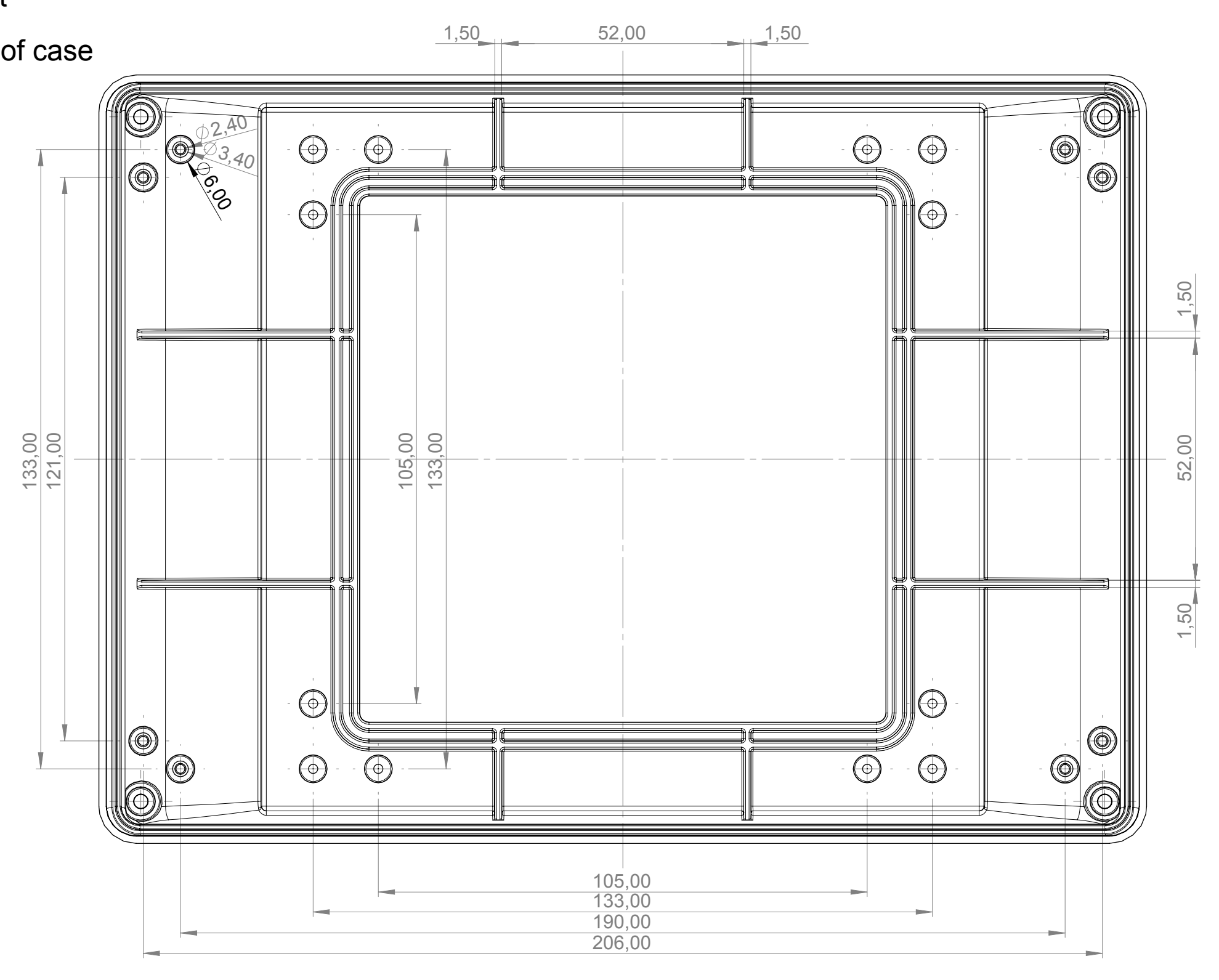

Gehäuseoberteil
nur bei entsprechender
Variante
Top part of case
only in the relevant
version

Dichtung
Sealing

Gehäuseunterteil
Bottom part of case

Dichtung
Sealing

Bodenplatte
Bottom panel

Rastleiste
Snap-in strip

B4044127 mit Gehäuseoberteil
with top part
B4044227 ohne Gehäuseoberteil
without top part

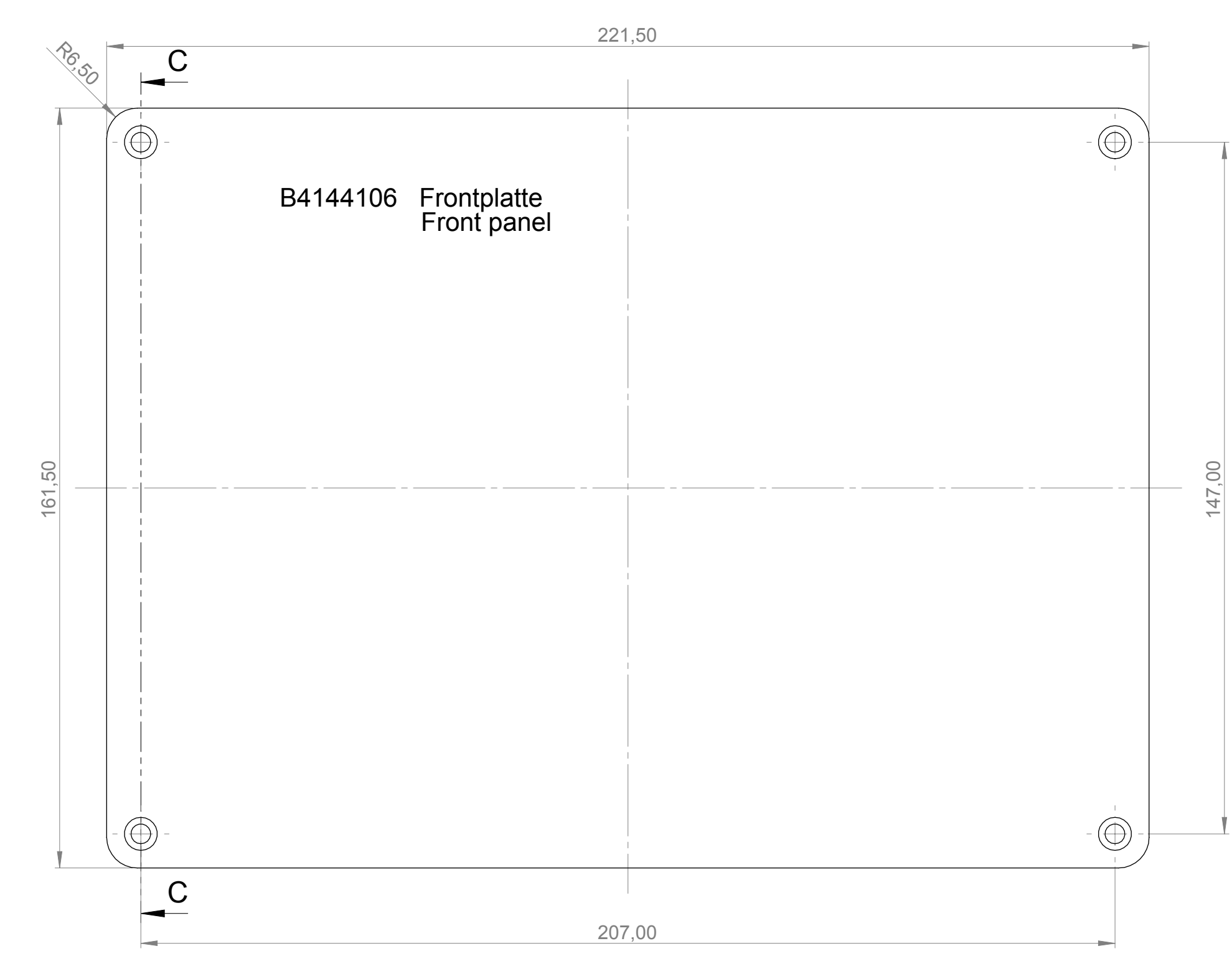
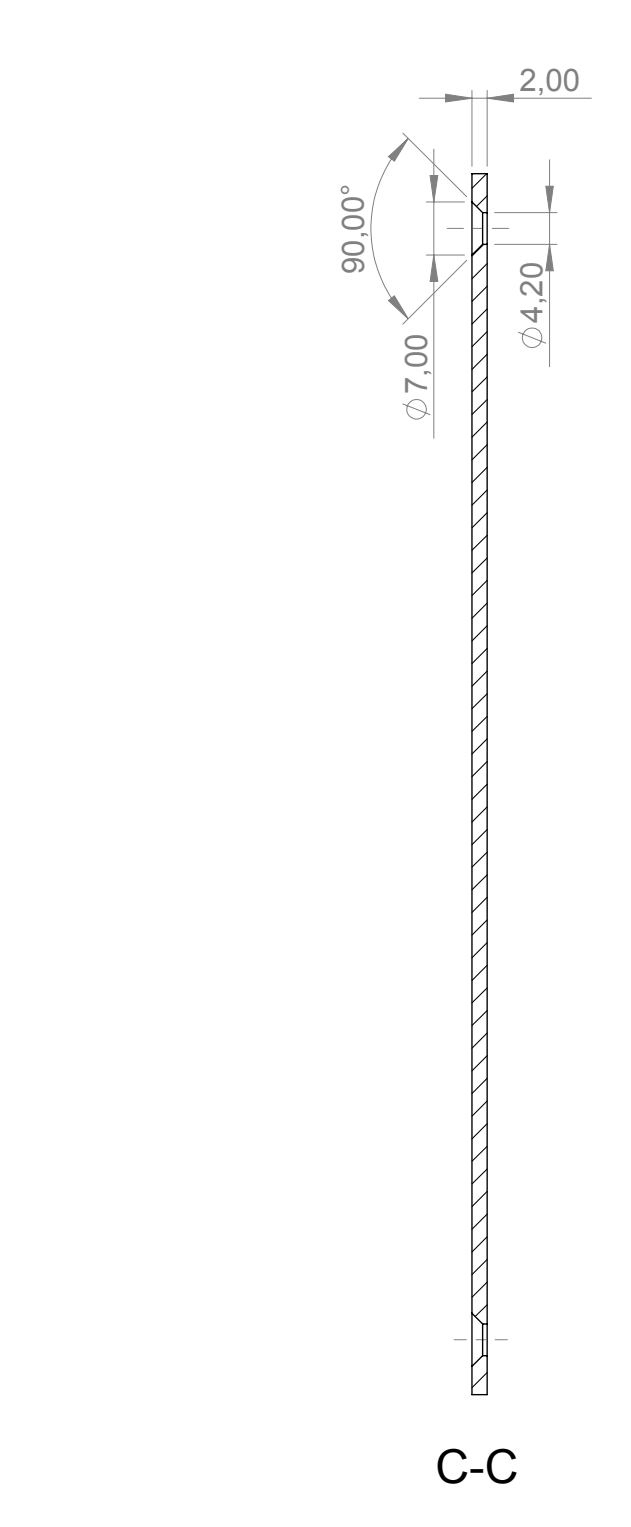

B4144106 Frontplatte
Front panel

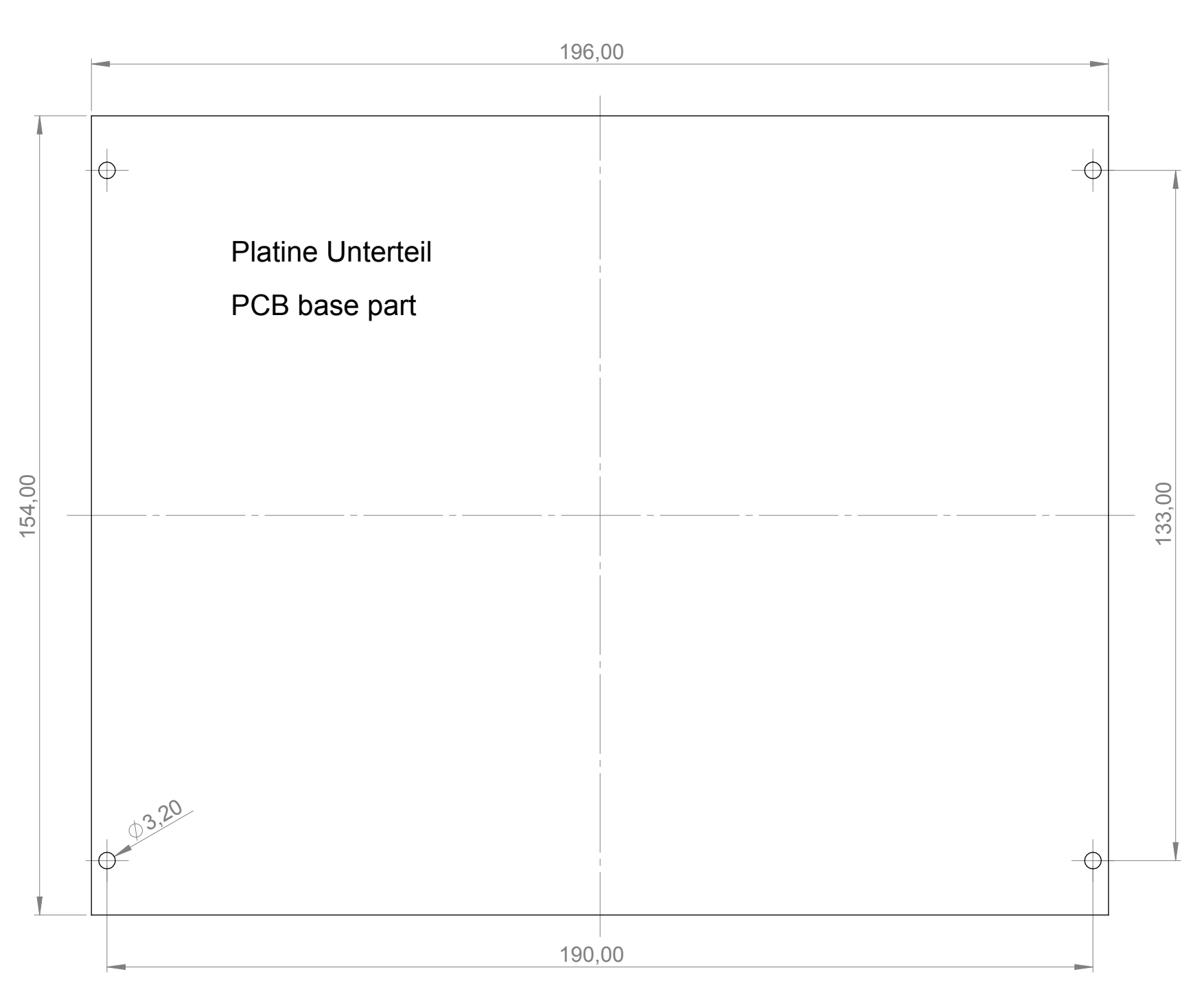

Platine Unterteil
PCB base part